

**SAS 8 SLOTTED HEADER - REG**  
**LIVE AREA - 22 7/16" W X 9" H**

**NYSCO**  
NYSCO PRODUCTS LLC  
**NYSCO Products, LLC**  
211 Saw Mill River Road,  
Hawthorne, NY 10532  
718-792-9000  
[www.nysco.com](http://www.nysco.com)

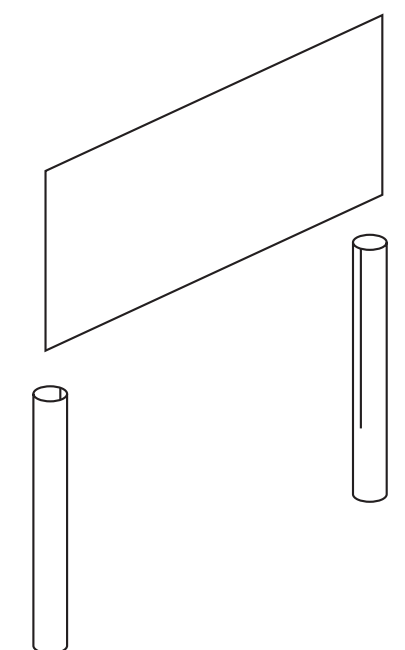

**HORIZONTAL BLEED ADD 1 3/4" LEFT & RIGHT**  
**VERTICAL BLEED ADD 1/4" TOP & BOTTOM**  
**OVER ALL SHEET SIZE - 25 7/16" W X 9" H**  
**SUBSTRATE - .048 SBS**  
**SCALE - FULL SIZE**



**FRONT VIEW OF SLOTTED HEADER**