

SAS 5 TAPE ON BACK HEADER - TALL
LIVE AREA - 20 1/2" W X 12" H

NYSCO
NYSCO PRODUCTS LLC

NYSCO Products, LLC
211 Saw Mill River Road,
Hawthorne, NY 10532
718-792-9000
www.nysco.com

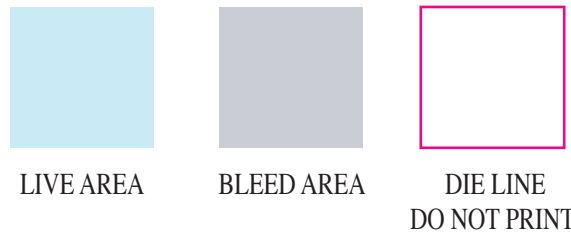

HORIZONTAL BLEED ADD 1/4" LEFT & RIGHT
VERTICAL BLEED ADD 1/4" TOP & BOTTOM
OVER ALL SHEET SIZE - 20 1/2" W X 12" H
SUBSTRATE - .048 SBS
SCALE - FULL SIZE

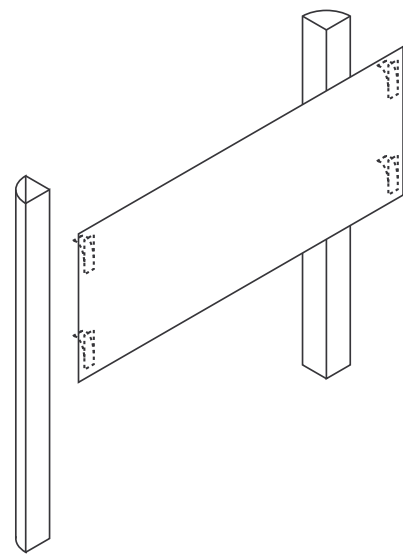

FRONT VIEW OF TAPE ON BACK HEADER