

SAS 11 SLOTTED HEADER - TALL
LIVE AREA - 15 5/8" W X 12" H

NYSCO
NYSCO PRODUCTS LLC

NYSCO Products, LLC
211 Saw Mill River Road,
Hawthorne, NY 10532
718-792-9000
www.nysco.com



HORIZONTAL BLEED ADD 1 3/4" LEFT & RIGHT
VERTICAL BLEED ADD 1/4" TOP & BOTTOM
OVER ALL SHEET SIZE - 18 5/8" W X 12" H
SUBSTRATE - .048 SBS
SCALE - FULL SIZE

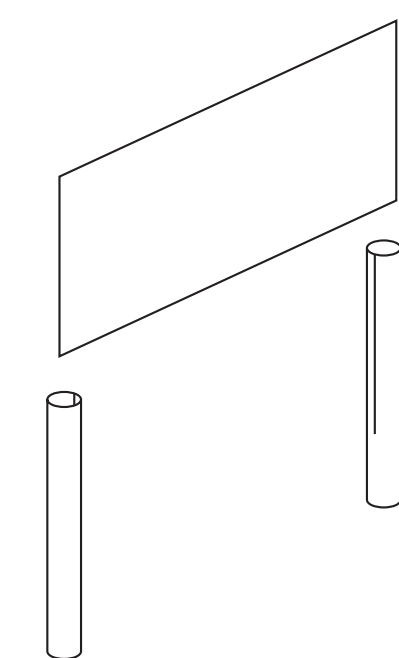

FRONT VIEW OF SLOTTED HEADER