

**SAS 23 SLOTTED HEADER - REG**  
**LIVE AREA - 18 5/16" W X 9" H**

**NYSKO**  
NYSKO PRODUCTS LLC

**NYSKO Products, LLC**  
211 Saw Mill River Road,  
Hawthorne, NY 10532  
718-792-9000  
[www.nysco.com](http://www.nysco.com)



LIVE AREA



BLEED AREA



DIE LINE  
DO NOT PRINT

**HORIZONTAL BLEED ADD 1 3/4" LEFT & RIGHT**  
**VERTICAL BLEED ADD 1/4" TOP & BOTTOM**  
**OVER ALL SHEET SIZE - 21 5/16" W X 9" H**  
**SUBSTRATE - .048 SBS**  
**SCALE - FULL SIZE**

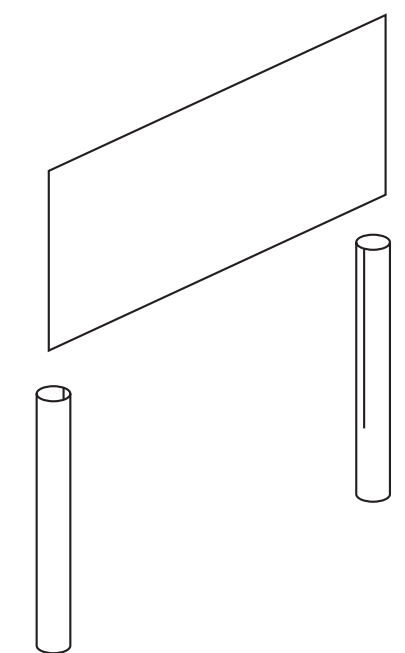

**FRONT VIEW OF SLOTTED HEADER**